



Quick Start Guide

V2.0

IRIS

**Thermal Imaging
Monocular**

IL19/IL35

EN/DE/IT/FR/ES

EN

Please read this guide before using the product, and keep the guide for future reference.

For detailed information about the device, please download the complete user manual from the official website (www.infirayoutdoor.com).

DE

Bitte lesen Sie dieses Handbuch sorgfältig durch, bevor Sie dieses Produkt verwenden, und bewahren Sie es zum späteren Nachschlagen gut auf.

Ausführliche Informationen über das Gerät finden Sie im vollständigen Benutzerhandbuch, das Sie von der offiziellen Website (www.infirayoutdoor.com) herunterladen können.

IT

Si prega di leggere questa guida prima di utilizzare il prodotto e conservarla per riferimento futuro.

Per informazioni dettagliate sul dispositivo, si prega di scaricare il manuale d'uso completo dal sito ufficiale (www.infirayoutdoor.com).

FR

Veillez consulter ce manuel avant d'utiliser le produit et gardez-le pour vous y référer ultérieurement.

Pour plus d'informations sur l'appareil, veuillez télécharger le manuel d'utilisation complet sur le site officiel (www.infirayoutdoor.com).

ES

Lea esta guía antes de usar el producto y conserve la guía para referencia futura.

Para obtener información detallada sobre el dispositivo, descargue el manual de usuario completo del sitio web oficial (www.infirayoutdoor.com).

Important Safety Information

Environmental influences

Never point the lens of the device directly at intense heat sources such as the sun or laser equipment. The objective lens and eyepiece can function as a burning glass and damage the interior components.

Risk of swallowing

Do not place this device in the hands of small children. Incorrect handling can cause small parts to come loose which may be swallowed.

Safety instructions for use

- Handle the device with care: rough handling may damage the battery.
- Do not expose the device to fire or high temperatures.
- Install the batteries correctly according to the instruction on the device. Reverse connection is prohibited.
- The battery capacity decreases when operated in a cold ambient temperature. This is not a fault and occurs for technical reasons.
- Always store the device in a dry, well-ventilated space. For prolonged storage, remove the batteries.
- The recommended temperature for using this product is -20° to $+50^{\circ}$. Otherwise, it will affect the service life of the product.
- Do not store the device for long periods at temperatures below 20°C or above 50°C , or this will permanently reduce the capacity of the battery.
- If the device has been damaged or the battery is defective, send the device to our after-sales service for repair.

EU Compliance Statement

Wireless transmitter module frequency range:

WLAN: 2.412-2.472GHz (For EU)

Wireless transmitter module power < 20dBm (only for EU)



We, InfiRay Technologies Co., Ltd. hereby declares that the radio equipment types SLIM are in compliance with the Directives 2014/53/EU and 2011/65/EU.

Disposal of batteries



2023/1542 (Battery Regulation): This product contains a battery that cannot be disposed of as unsorted municipal waste in the European Union. For battery details, refer to the documentation of the specific product. The battery is marked with this symbol, which may include Cd (indicating cadmium), Pb (indicating lead), or Hg (indicating mercury). For proper recycling, please return the battery to your supplier or send it to a designated collection point. For more information, visit www.recyclethis.info.

User information on the disposal of electrical and electronic devices (private households)



2012/19/EU (WEEE directive): Products marked with this symbol cannot be disposed of as unsorted municipal waste in the European Union. For proper recycling, return this product to your local supplier upon the purchase of equivalent new equipment, or dispose of it at designated collection points. For more information see: www.recyclethis.info.

For business customers within the European Union

Please contact your dealer or supplier regarding the disposal of electrical and electronic devices. He will provide you with further information.

Information on disposal in other countries outside of the European Union

This symbol is only applicable in the European Union. Please contact your local authority or dealer if you wish to dispose of this product and ask for a disposal option.

Intended use

The device is intended for displaying heat signatures during nature observation, remote hunting observations and for civil use. This device is not a toy for children.

Use the device only as described in this operating manual. The manufacturer and the dealer accept no liability for damages which arise due to non-intended or incorrect use.

Function test

Before use, please ensure that your device has no visible damage.

Test to see if the device displays a clear, undisturbed image.

Check that the settings for the thermal imaging monocular are correct.

Installing/Removing the battery

The IRIS series thermal imaging scope need to install one 18650 battery for use. Refer to the section Battery Installation for details.

IRIS

Quick Start Guide



EN

Thermal Imaging Monocular

1-10

DE

Wärmebild-Monokularfernrohr

11-20

IT

Monocolo per immagini termiche

31-40

FR

Monoculaire d'imagerie thermique

41-50

ES

Monocular de Imagen Térmica

51-60

Accessories

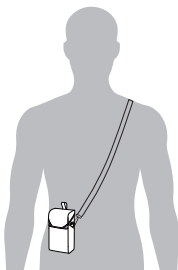
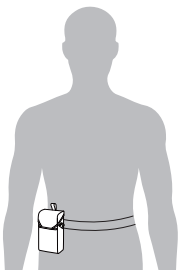
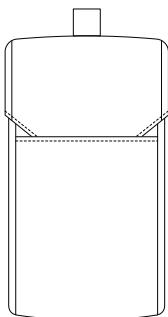
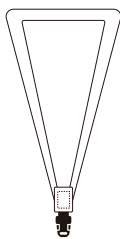
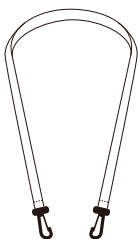
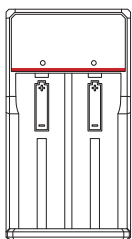
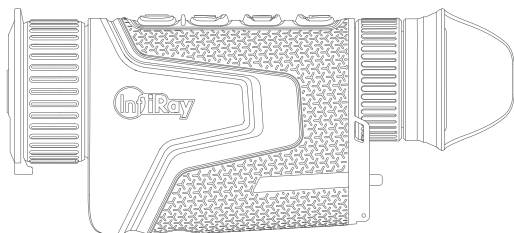

Battery Install

1

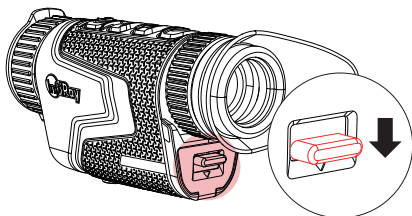

2

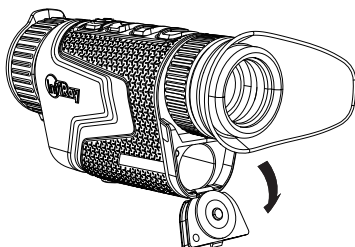

3

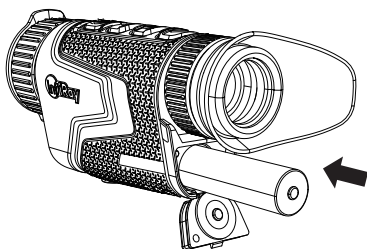

4

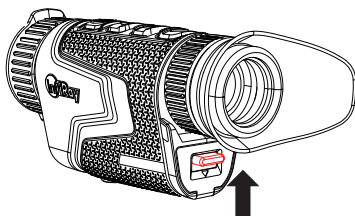

Button Descriptions



Shortcut Menu

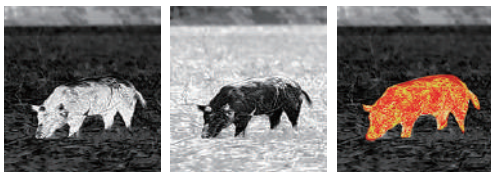

Main Menu

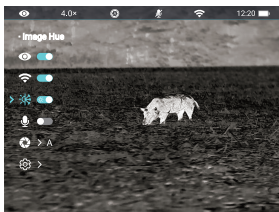
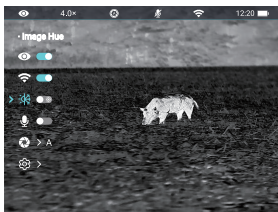

| App



InfiRay
Outdoor 2

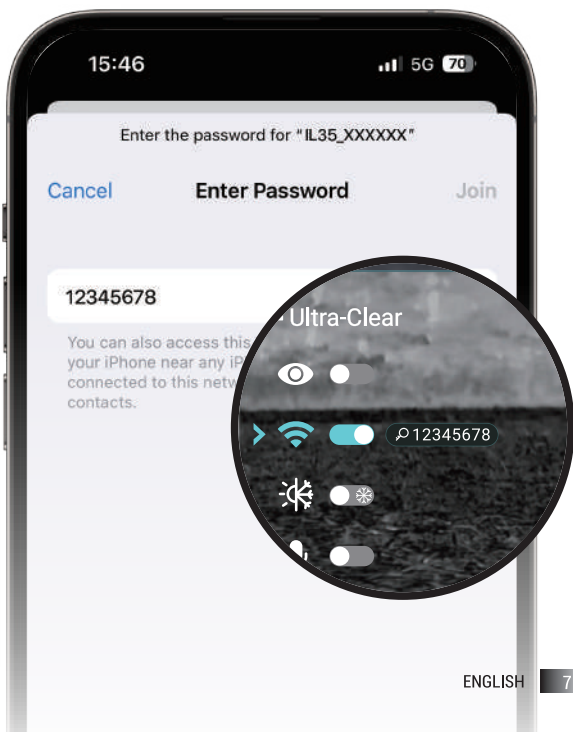



Firmware upgrade

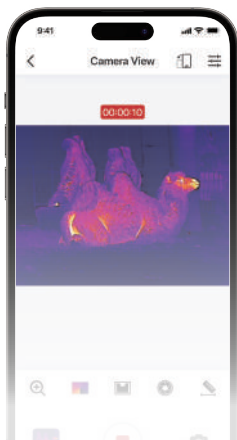

Real-time image transmission



Device file

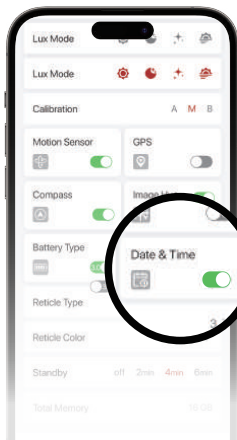

Date & Time calibration

Specifications

Model	IL19	IL35
Detector Specifications		
Resolution, pixels	384×288	
Pixel, μm	12	
NETD, mK	<20	
Frame rate, Hz	50	
Optical Specifications		
Objective lens, mm	19 F0.9	35 F0.9
Field of view (H×V), °	13.8×10.4	7.5×5.7
Linear field of view (H×V), m at 100m	24×18	13×10
Magnification, ×	2~8	4~16
Detective range, m (Target size: 1.7m × 0.5m, P(n)=99%)	980	1800
Exit relief, mm	25	
Exit pupil diameter, mm	10	
Diopter, D	-5 ~ +5	
Display Specifications		
Type	AMOLED	
Resolution, pixels	1024×768	
Battery Power Supply		
Battery	Replaceable li-ion battery 18650	
Max. Operation Time, h *	4	

Model	IL19	IL35
Physical Specifications		
MIC	Support	
Memory capacity, GB	32	
IP rating	IP67	
Operating temperature, °C	-20 ~ +50	
Weight, g (with battery)	≤330	
Dimension, mm	≤143×47×74	

* The Operation time is tested in -20°C and 22°C environment. The device is turned on R+ and W-Fi is turned off by default.

Get More Information



Website:
infirayoutdoor.com



User manual

Zubehör

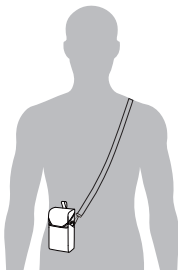
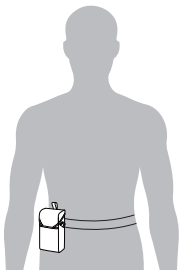
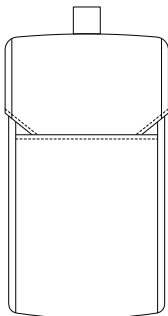
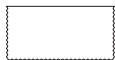
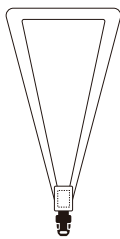
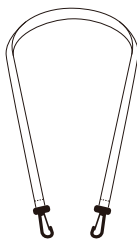
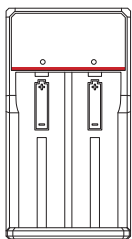
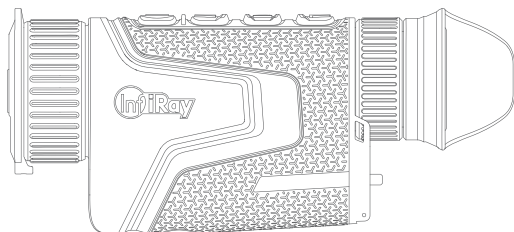

Batterie installieren

1

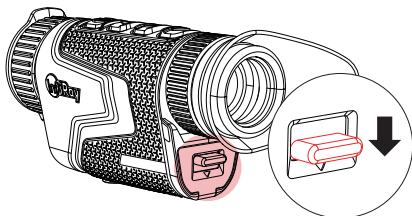

2

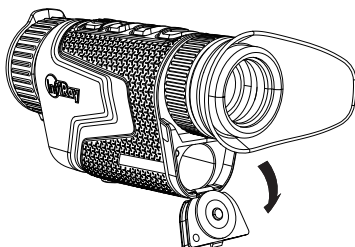

3

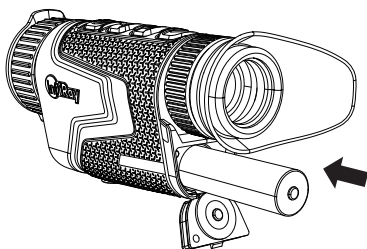

4

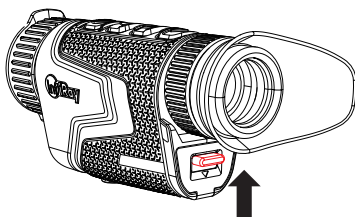

Schlüsselbeschreibung

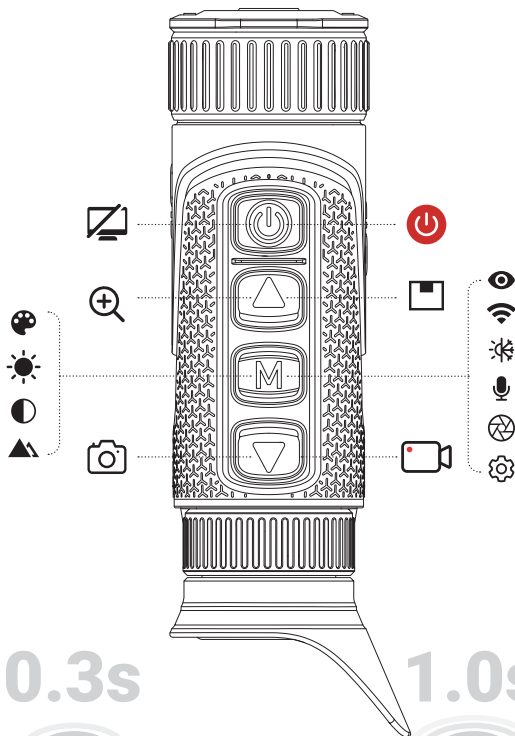

Schlüsselbeschreibung



Kontextmenü

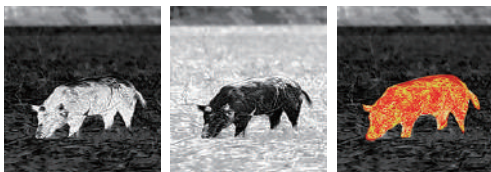

Hauptmenü

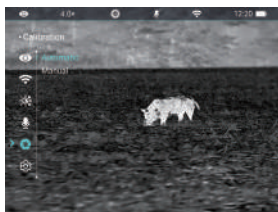
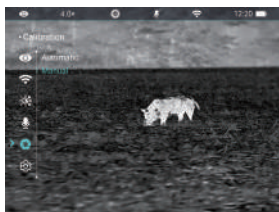
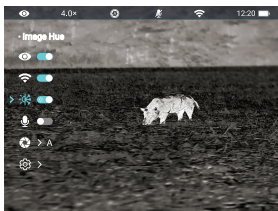
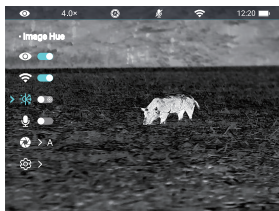

Manuell



Automatisch

| App



InfiRay
Outdoor 2

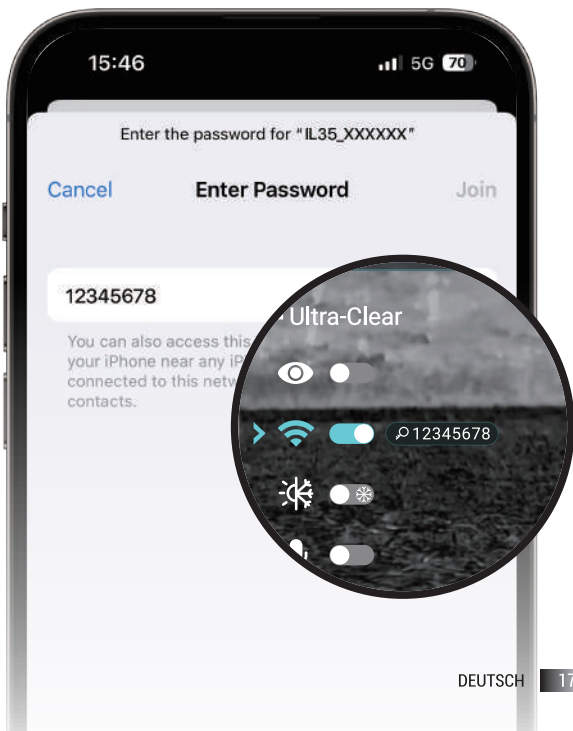



Firmware Upgrade

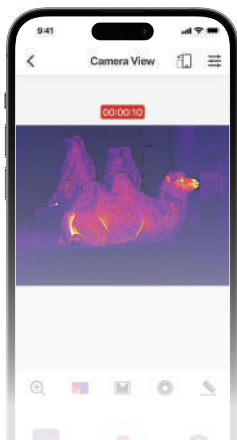

Bildübertragung in Echtzeit



Gerätedatei

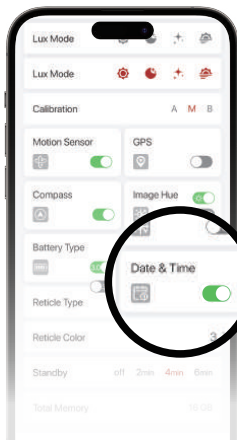

Kalibrierung von Datum und Uhrzeit

Spezifikationen

Modul	IL19	IL35
Mikrobolometer		
Auflösung, Pixel	384×288	
Pixelgröße, µm	12	
NETD, mK	< 20	
Bildrate, Hz	50	
Optische Spezifikationen		
Objektivlinse, mm	19 F0.9	35 F0.9
Sichtfeld,°	13.8×10.4	7.5×5.7
Lineares Sichtfeld (HxV), m bei100m	24×18	13×10
Vergrößerung,x	2~8	4~16
Detektionsbereich,m (Zielgröße: 1.7mx0,5m,P(n)=99%)	980	1800
Abstand derAustrittspupille,mm	25	
Durchmesser derAustrittspupille ,mm	10	
Dioptrien, D	-5 ~ +5	
Display Spezifikationen		
Typ	AMOLED	
Auflösung, pixels	1024×768	
Stromversorgung		
Batterietyp	Austauschbarer Li-Ion 18650	
Max.Batterielebensdauer,h *	4	

Modul	IL19	IL35
Physikalische Spezifikationen		
Mikrofon	Unterstützt	
Eingebaute Speichergröße, GB	32	
IP-Bewertung	IP67	
Betriebstemperatur, °C	-20 ~ +50	
Gewicht, g (mit Batterie)	≤330	
Abmessung, mm	≤143×47×74	

* Die Betriebszeit wird in Umgebungen mit Temperaturen von -20 °C und 22 °C getestet. Das Gerät ist standardmäßig auf R+ eingestellt und Wi-Fi ist ausgeschaltet.

Mehr Informationen bekommen



Webseite:
infirayoutdoor.com



Benutzerhandbuch

Accessori

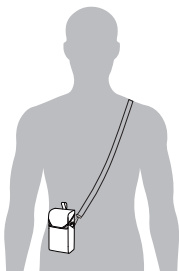
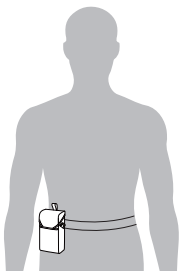
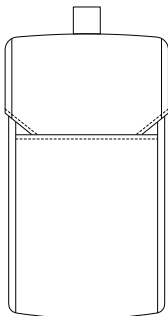
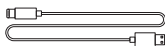
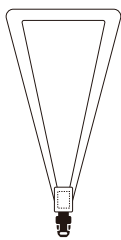
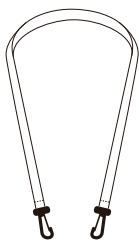
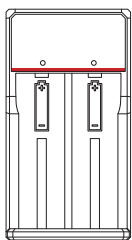
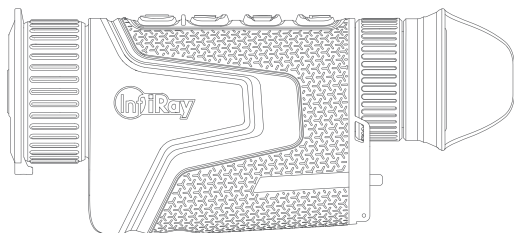

Installazione della batteria

1

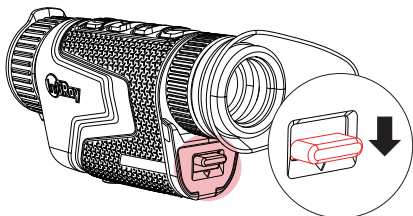

2

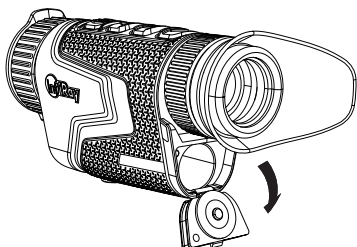

3

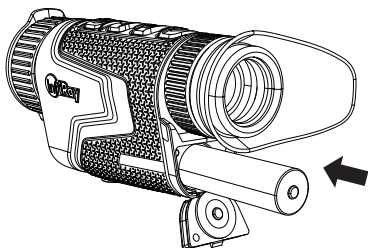

4

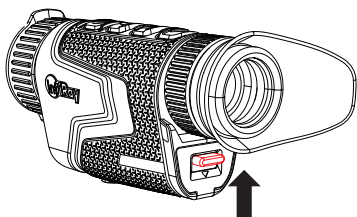

Descrizioni dei pulsanti

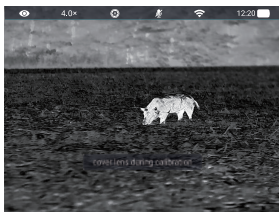

Menu di scelta rapida

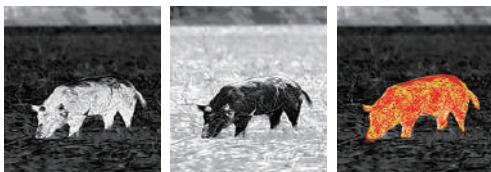

Menu principale

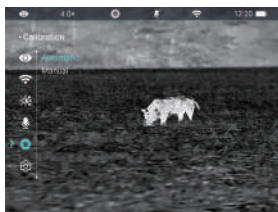
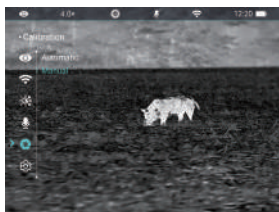
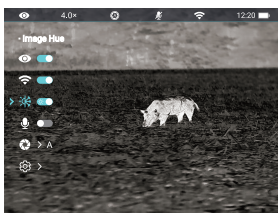
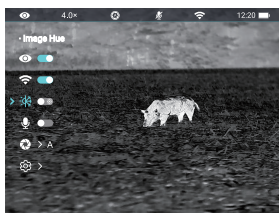

Manuale



Automatica

| App



InfiRay
Outdoor 2

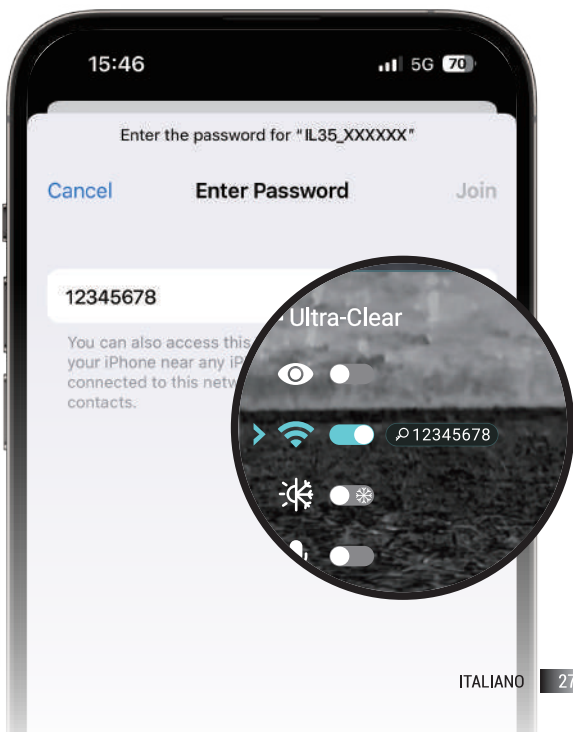

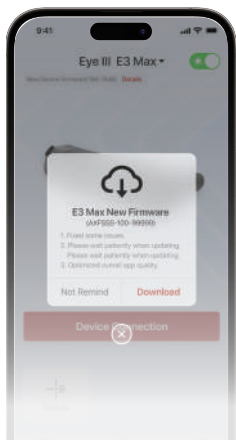

Aggiornamento
del firmware

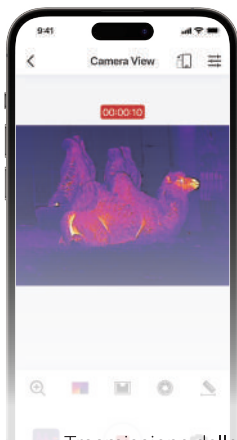

Trasmissione delle
immagini in tempo
reale



File del
dispositivo

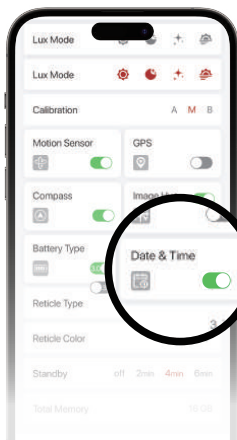

Calibrazione di
data e ora

Specifiche

Modello	IL19	IL35
Microbolometro		
Risoluzione, pixel	384×288	
Dimensione del Pixel, um	12	
NETD, mK	< 20	
Frequenza dei fotogrammi, Hz	50	
Specifiche ottiche		
Lente dell'obiettivo, MM	19 F0.9	35 F0.9
Campo visivo,°	13.8×10.4	7.5×5.7
Campo visivo a lineare (H x V), m a 100 m	24×18	13×10
Ingrandimento, x	2~8	4~16
Campo di Rilevamento, m (Dimensione del bersaglio: 1.7 m x 0.5m, P(n)= 99%)	980	1800
Distanza interoculare, mm	25	
Diametro della Pupilla d'uscita, mm	10	
Diottria, D	-5 ~ +5	
Display		
TipO	AMOLED	
Risoluzione, pixel	1024×768	
Alimentazione		
Batteria	Ioni di litio sostituibili 18650	
Durata della batteria massima, h *	4	

Modello	IL19	IL35
Specifiche operative		
microfono	Supporta	
Quantità di memoria incorporata, GB	32	
Grado di protezione IP	IP67	
Temperatura di Funzionamento, °C	-20 ~ +50	
Peso, g (con batteria)	≤330	
Dimensione, mm	≤143×47×74	

* L'orario di lavoro è testato in ambienti a -20 °C e 22 °C . Il dispositivo è acceso R+ e il Wi-Fi è disattivato per impostazione predefinita.

Otteni maggiori informazioni



Sito web:
infirayoutdoor.com



Manuale d'uso

Accessoires

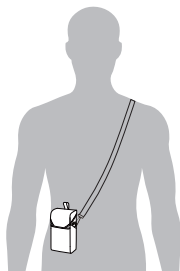
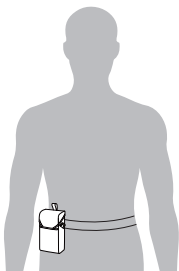
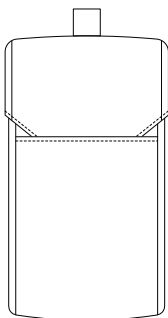
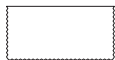
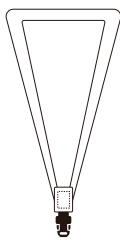
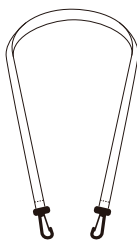
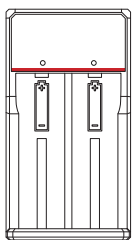
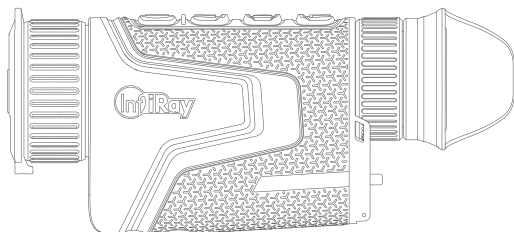

Installation de la batterie

1

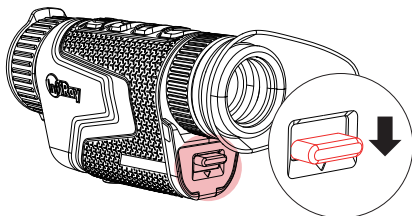

2

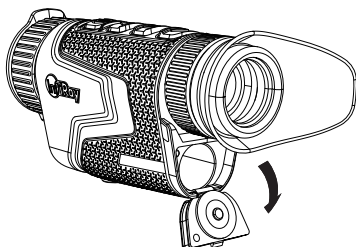

3

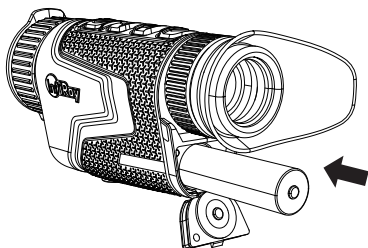

4

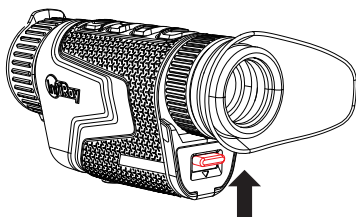

Description des boutons

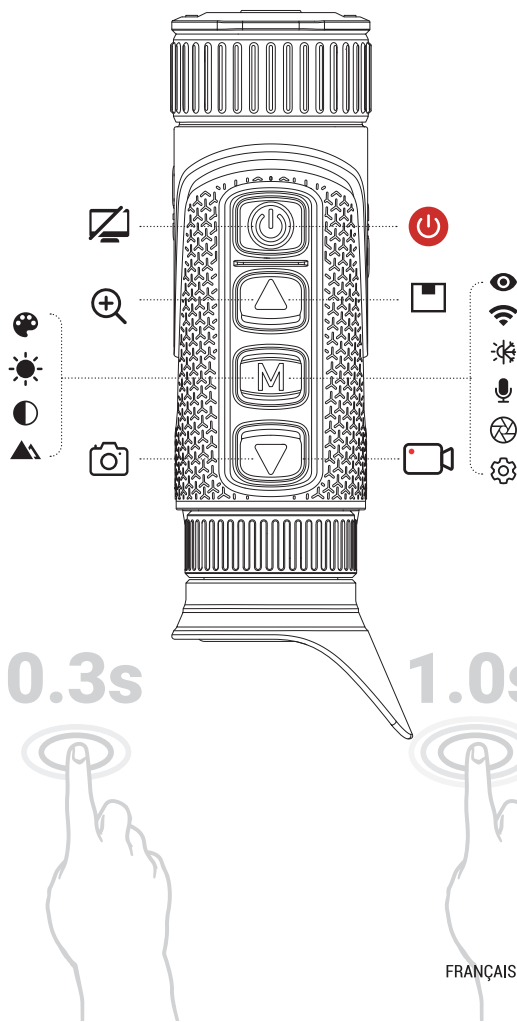

Description des boutons

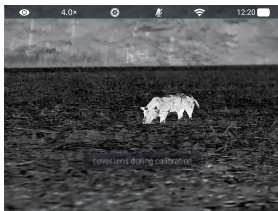

Menu des raccourcis

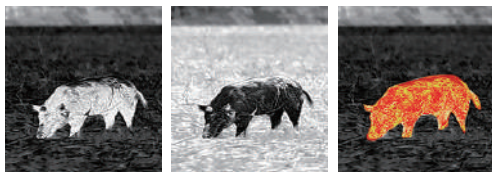

Menu principal

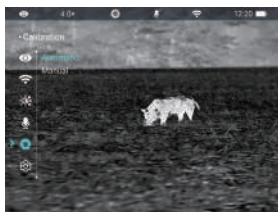
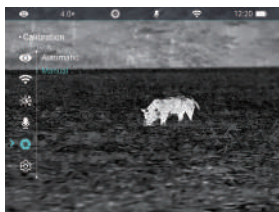
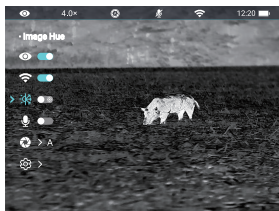

Manuel



Automatique

| App



InfiRay
Outdoor 2

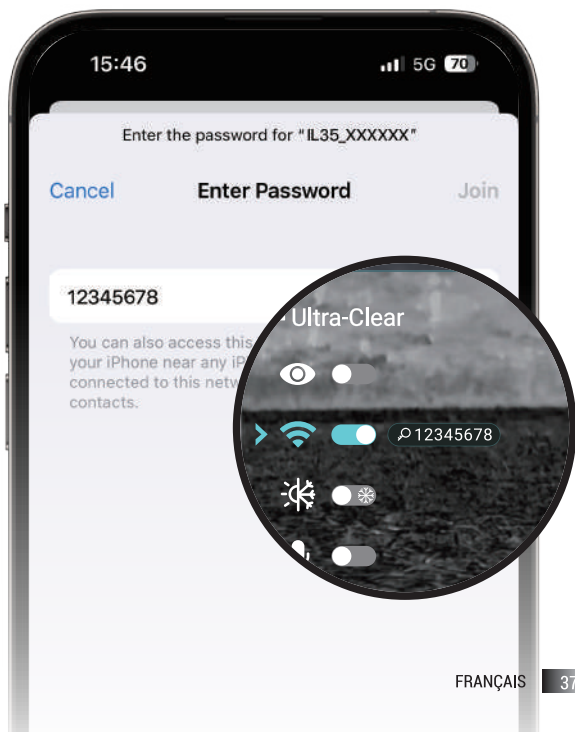



Mise à jour du
firmware

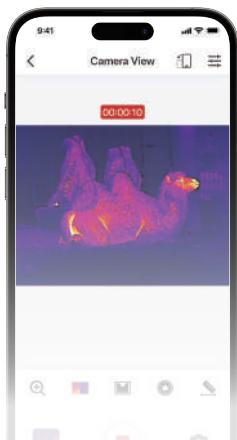

Transmission d'images
en temps réel



Fichier de
périphérique

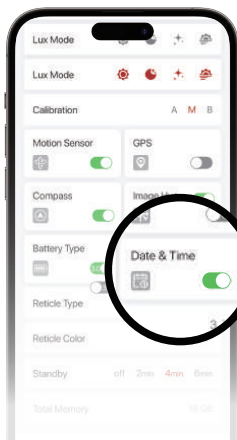

Calibrage de la date
et de l'heure

Spécifications

Modèle	IL19	IL35
Microbolomètre		
Résolution, pixels	384×288	
Taille des pixels, µm	12	
NETD, mK	< 20	
Fréquence des frames, Hz	50	
Spécifications optiques		
Objectif principal, MM	19 F0.9	35 F0.9
Champ de vision,°	13.8×10.4	7.5×5.7
Champ de vision linéaire (H x V), m à 100m	24×18	13×10
Grossissement, x	2~8	4~16
Portée de détection, m (taille de la cible: 1.7 m x 0.5 m, P(n) =99%)	980	1800
Distanza interoculare, mm	25	
Diamètre de la pupille de sortie, mm	10	
Dioptrie, D	-5 ~ +5	
Écran		
Type	AMOLED	
Résolution, pixels	1024×768	
Alimentation électrique		
Type de batterie	Li-ion remplaçable 18650	
Autonomie maximale de la batterie, h*	4	

Modèle	IL19	IL35
Spécifications de fonctionnement		
microphone	Support	
Capacité de la mémoire intégrée, Go	32	
Indice IP	IP67	
Température de fonctionnement, °C	-20 ~ +50	
Poids, g (avec batterie)	≤330	
Dimensions, mm	≤143×47×74	

* Le temps de travail est testé dans un environnement de -20 °C et 22 °C . L'appareil est allumé R+ et le Wi-Fi est désactivé par défaut.

Obtenir plus d'informations



Site web:
infirayoutdoor.com



Manuel de l'Utilisateur

Accesorios

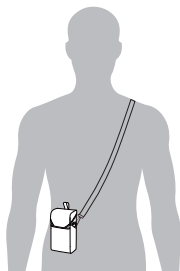
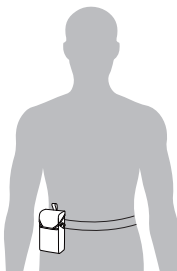
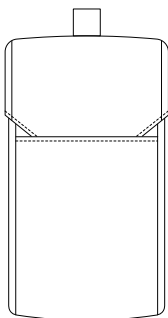
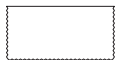
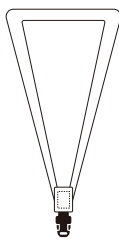
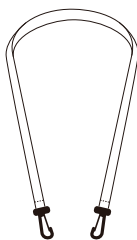
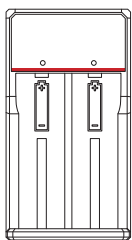
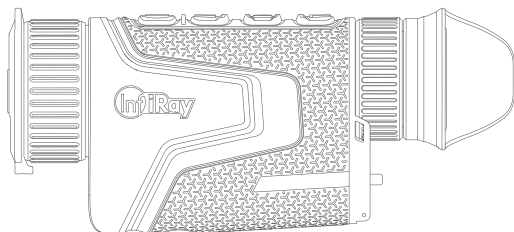

Instalación de la batería

1

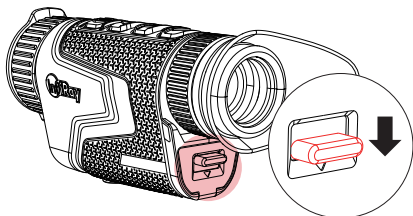

2

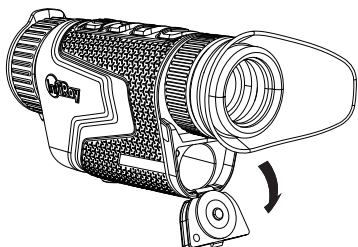

3

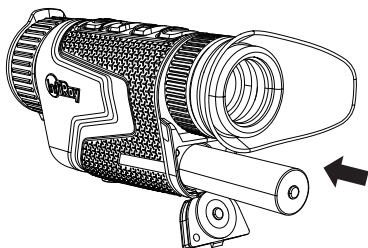

4

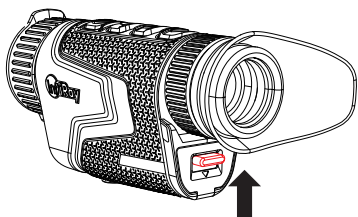

Descripciones de botones

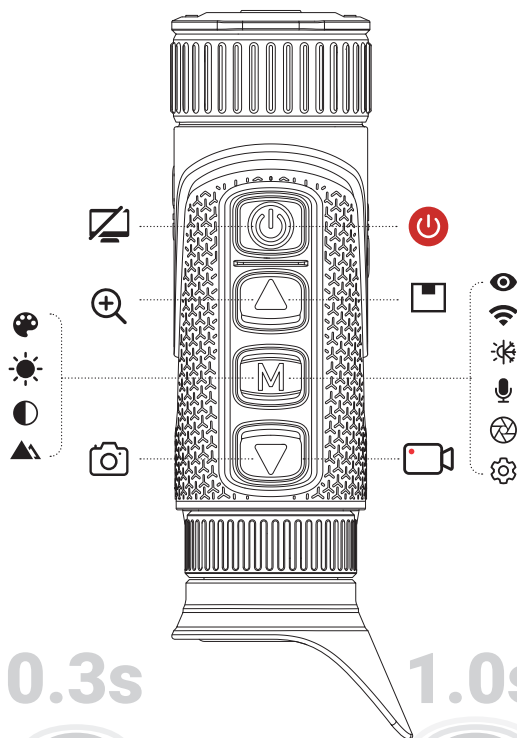

Descripciones de botones

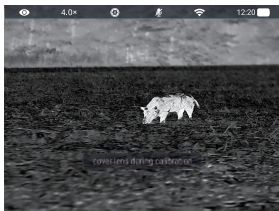

Menú breve

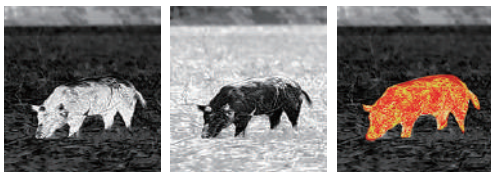

Menú principal

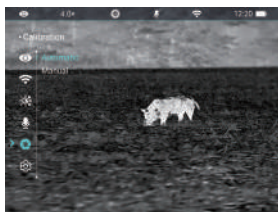
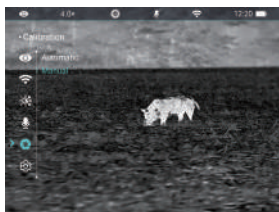
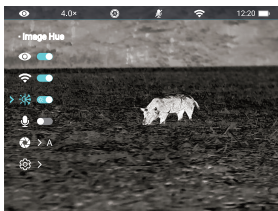
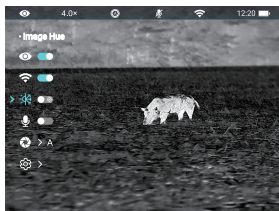

Manual



Automática

| App



InfiRay
Outdoor 2

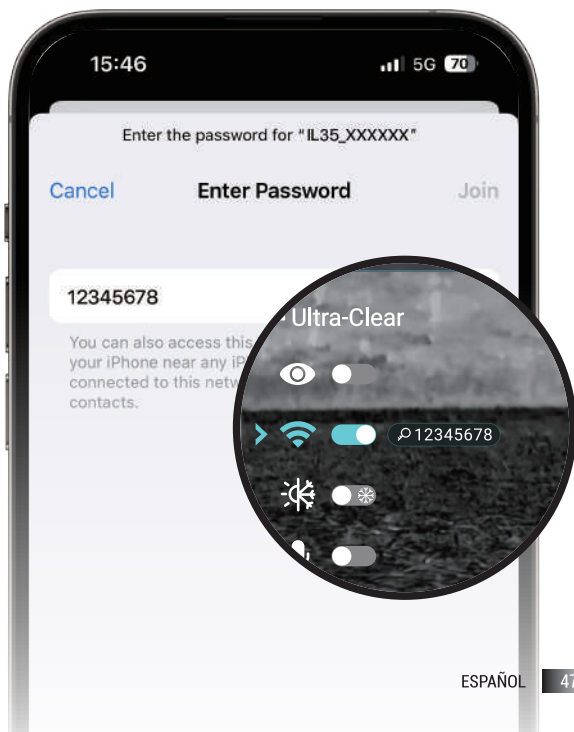



Actualización
de firmware

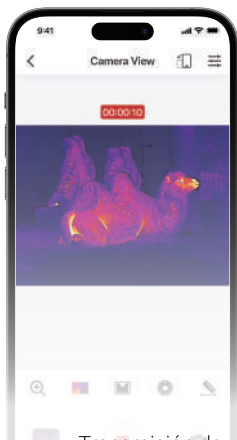

Transmisión de
imágenes en
tiempo real



Archivo de
dispositivo

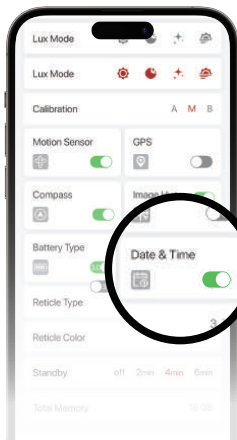

Calibración de
fecha y hora

Especificaciones

Modelo	IL19	IL35
Microbolómetro		
Resolución, pixeles	384×288	
Tamaño de pixeles, um	12	
NETD, mK	< 20	
Velocidad de fotogramas, Hz	50	
Especificaciones Ópticas		
Lente Objetiva, MM	19 F0.9	35 F0.9
Campo de visión,°	13.8×10.4	7.5×5.7
Campo de Visión Lineal (HxV), m a 100 m	24×18	13×10
Magnificación,x	2~8	4~16
Rango de detección, m(Tamaño objetivo: 1.7m x 0,5 m,P(n)=99%)	980	1800
Alivio ocular, mm	25	
Diámetro de la pupila de salida,mm	10	
Dioptrias, D	-5 ~ +5	
Pantalla		
Tipo	AMOLED	
Resolución, pixeles	1024×768	
Fuente de Alimentación		
Batería	Li-ion reemplazable 18650	
Vida útil máxima de labatera, h *	4	

Modelo	IL19	IL35
Especificaciones Operativas		
micrófono	Soporte	
Cantidad de memoria incorporada,GB	32	
Clasificación IP	IP67	
temperatura defuncionamiento. °C	-20 ~ +50	
Peso, g (con batería)	≤330	
Dimensión, mm	≤143×47×74	

* El tiempo de trabajo se prueba en ambientes de -20 °C y 22 °C . El dispositivo está encendido en R+ y el Wi-Fi está apagado de forma predeterminada.

Obtener mas informacion



Sitio web:
infirayoutdoor.com



Manual de usuario



InfiRay Technologies Co., Ltd.

☎ 0086-400-999-3800

🌐 www.infirayoutdoor.com

✉ infirayoutdoor@infiray.com

📍 Room 301, Building C3, No.800 Wangjiang West Road, Hefei, Anhui, P.R.China

